

KONA Electric

Emergency Response Guide

Contents

1. Identification / recognition	2
2. Immobilization / stabilization / lifting	6
3. Disable direct hazards / safety regulations	7
4. Access to the occupants	12
5. Stored energy / liquid / gases / solids	15
6. In case of fire	18
7. In case of submersion	22
8. Towing / Transportation / storage	23
9. Important additional information	26

1. Identification / recognition

Initial Response: Identify, Immobilize and Disable

The following procedures should be used whenever you are dealing with a KONA EV at an emergency scene. However, all operations should be consistent with your department's standard operating procedures, guidelines, and any applicable laws. When an EV is damaged in a crash, the high voltage safety systems may have been compromised and present a potential high voltage electrical shock hazard. Exercise caution and wear appropriate personal protective equipment (PPE) safety gear, including high voltage safety gloves and boots. Remove all metallic jewelry, including watches and rings.

Identify

The KONA EV is an electric vehicle. Emergency responders should respond to emergency scenarios involving the KONA EV accordingly, exercising extreme care and caution to avoid contact with the high voltage system within the vehicle.



1. Identification / recognition

1.1 Identifying a HYUNDAI KONA EV

“electric” logo on tail gate

- The HYUNDAI KONA EV can be easily identified by the “Eco electric” logo attached on the tail gate and front charge port door on driver’s side.
- The eco electric logo may be missing or hidden after a crash due to damage to the vehicle. Always be sure to utilize additional methods of identification before determining that the vehicle is not an electric car.



Charging Port

- The charging port is located on the front left bumper.
- #Note : The doors must be un-locked to open the charge port door.

How to open the charging port



Unlock charging door in emergency

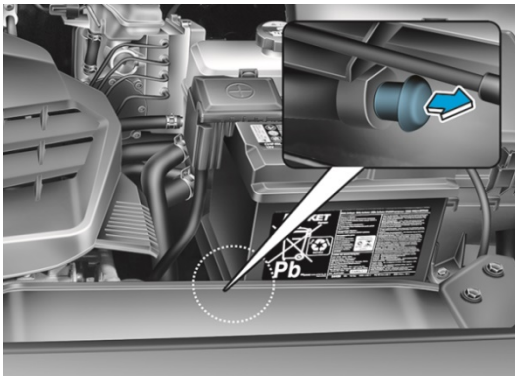

1. Identification / recognition

1.1 Identifying a HYUNDAI KONA EV

VIN Label

The VIN (Vehicle Identification Number) identifies an electric car with a “G” or “H” displayed in the 8th position, as shown in the below picture.

The VIN can be found:

- 1) Underneath the front passenger seat (or driver seat).
- 2) On the vehicle certification label attached to the driver’s side (or passenger) center pillar.

XXXXXXXX**G or H**XXXXXX

← 8th position (G or H)

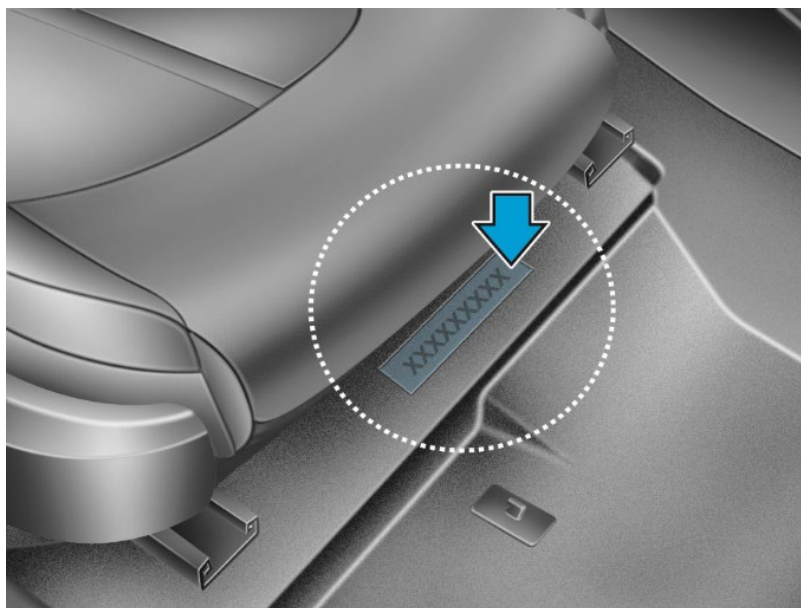

1. Identification / recognition

1.1 Identifying a HYUNDAI KONA EV

Motor Compartment and underside

The KONA Electric has a plastic power electric cover with “EV” clearly shown on it. Additionally, there are orange colored high-voltage electrical cables in the motor compartment and underside

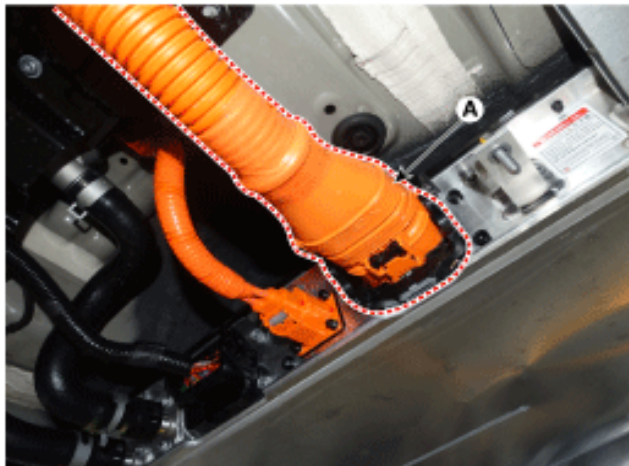

2. Immobilization / stabilization / lifting

2.1 Immobilization

The next step is to immobilize the vehicle to prevent any accidental movement that can endanger responding emergency personnel or civilians. When the KONA EV is damaged in a crash, the vehicle may appear to be shut off when it is not because the engine emits little to no sound.

When the "READY" mode light is illuminated on the Instrument Panel, the vehicle can move silently using the electric motor. Responders should approach the vehicle from the sides and stay away from the front or rear as they are potential paths for vehicle movement. Be sure to immobilize the vehicle in the following manner.



Step on brake pedal to park the vehicle, then press the park (P) Button

Engage Parking Brake

Chock the Wheels

2.2 Vehicle Stabilization

Use standard stabilization(lift) points, as shown right. Always be sure to connect to a structural member of the vehicle and avoid placing cribbing under high voltage cables, and other areas not normally considered acceptable.

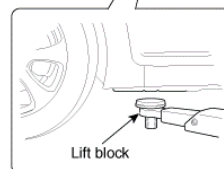
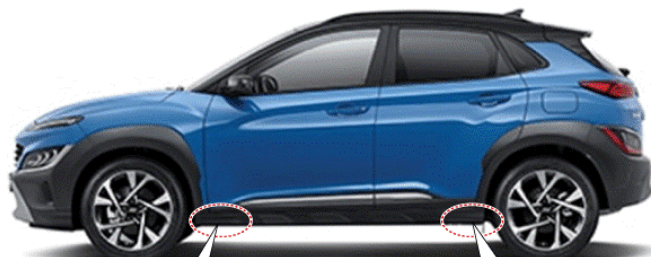

[Front]

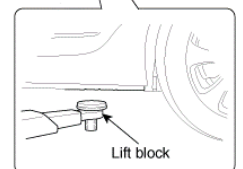

[Rear]

3. Disable direct hazards / safety regulations

The final step in the initial response process, conducted after immobilizing the vehicle, is to disable the vehicle, its SRS components and the high voltage electrical system. To prevent current flow through the system, use one of the following procedures to disable the vehicle.

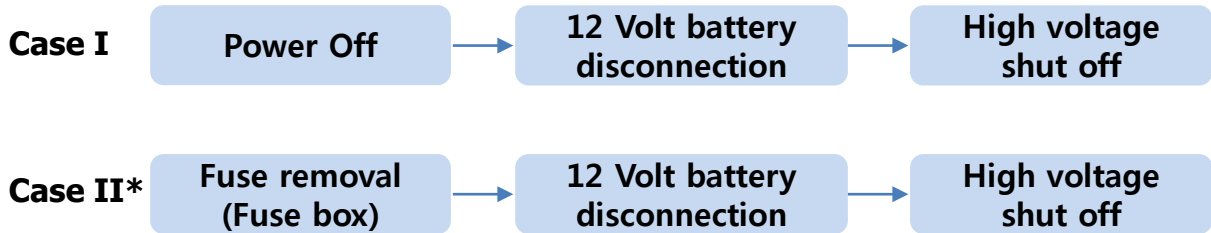

*In case of the vehicle cannot be disabled using the "power" button.

3.1 Disabling the System – Smart Key System and "POWER" START/STOP Button

1. Confirm the status of the READY light on the instrument panel. If the  READY light is illuminated, the vehicle is ON.
 - a) If the READY light is NOT illuminated, the vehicle is off. Do not push the "POWER" START/STOP button because the vehicle may start (go into READY mode).
 - b) To turn OFF the system, press the 'P' (Park) button, and press the POWER button.



"P" parking position button

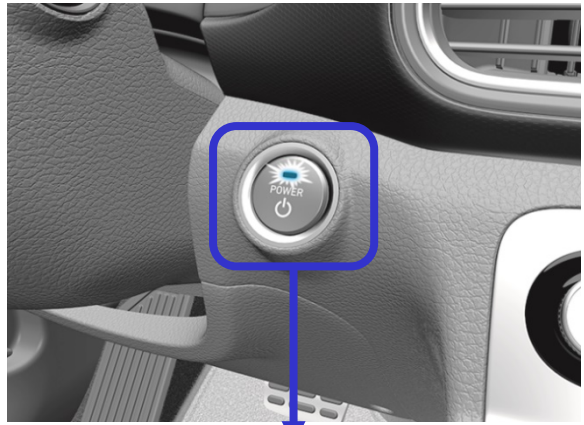

"POWER" START/STOP Button

3. Disable direct hazards / safety regulations

Without depressing the brake pedal

Pressing POWER button	Button Position/LED	Vehicle condition
One time	ACC/ON	Electrical accessories are operational.
Two times	ON/ON	The warning lights can be checked before the vehicle is started.
Three times	OFF	Off

While depressing the brake pedal

Pressing POWER button	Button Position/LED	Vehicle condition
One time	START/OFF	Ready to drive

2. If necessary, lower the windows, unlock the doors and open the tail gate as required, before disconnecting the 12 Volt battery. Once the 12 Volt battery is disconnected, power controls will not operate. (Refer to below “5. – a” for 12 Volt battery disconnection)
3. Before disconnecting the 12 Volt battery, remove the Smart Key at least 2 meters away from the vehicle to prevent accidental restart.
4. In case of emergency, disconnect or cut the service interlock connector cable to isolate the high voltage of the battery.

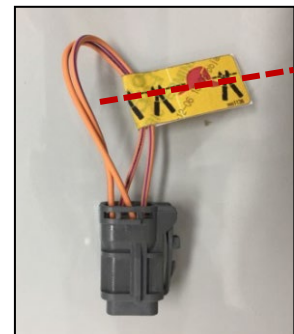
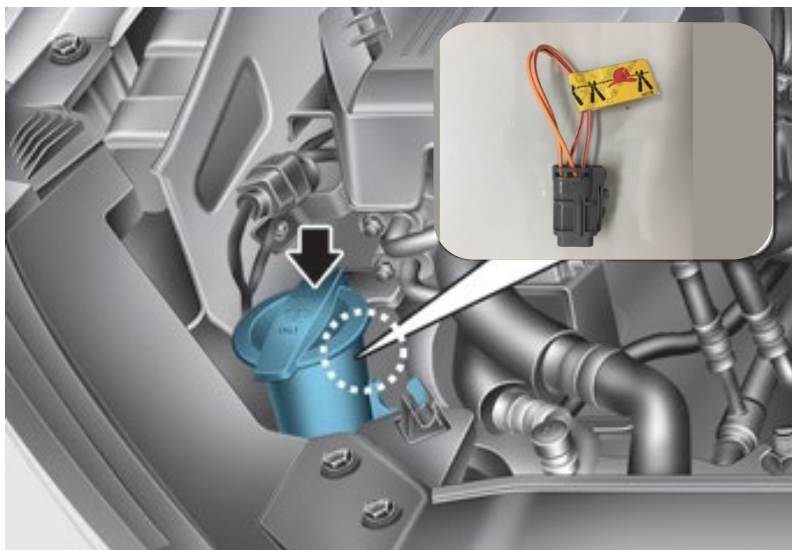

Service Interlock Connector

3. Disable direct hazards / safety regulations

5. Follow the procedure below to remove the safety plug and disable the high voltage battery:

a) Disconnect the 12 Volt auxiliary battery negative (-) terminal.

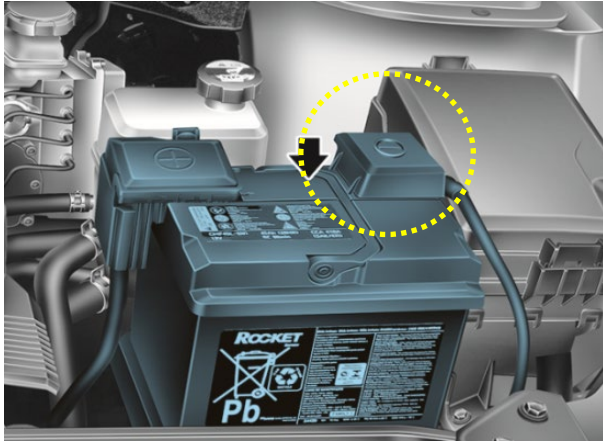

b) Remove the rear seat shown in the figure(illustration) below to locate the service plug.

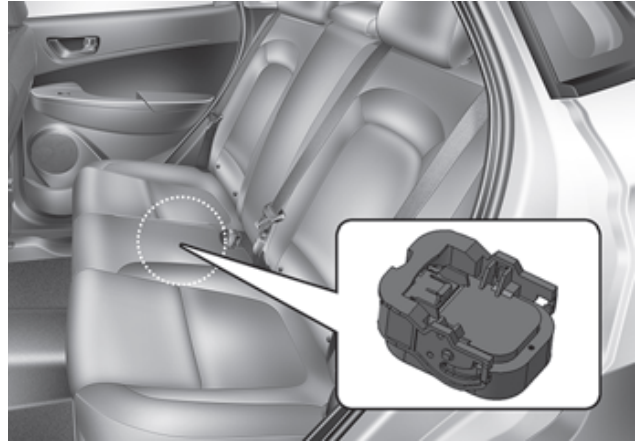

c) Remove the service plug cover (A) after removing rear seat cushion assembly.



d) Remove the service plug (A).

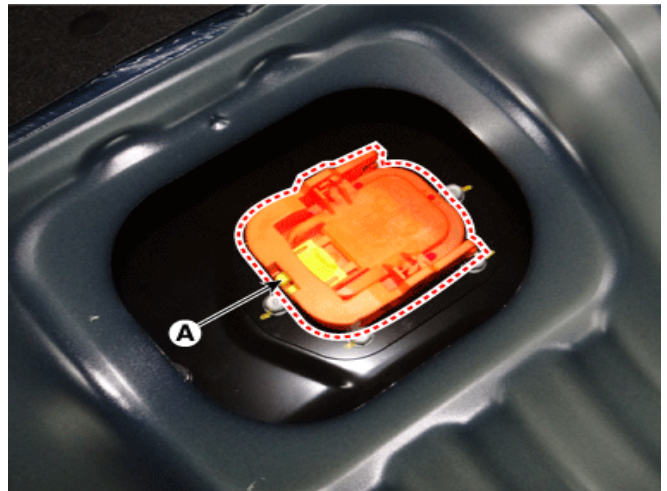

3. Disable direct hazards / safety regulations

3.2 Disabling the System – IG (Ignition) Fuse Removal

1. Open the hood.

2. Remove the motor room fuse box cover.

3. If necessary, lower the windows, unlock the doors and open the tail gate as required, before disconnecting the 12 Volt battery (located in the left side of motor room). Once the 12 Volt battery is disconnected, power controls will not operate.

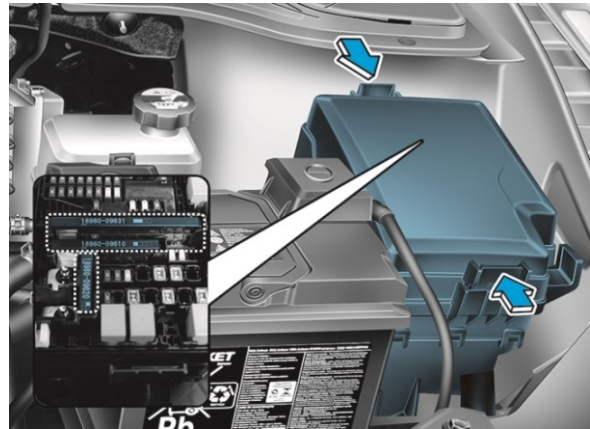

Motor room fuse box

4. In the event the vehicle is unable to be disabled using the “Power” START/STOP Button, using the fuse puller located in the Motor room fuse box, pull both the IG1, IG2 Fuse from the motor room fuse box. If the IG fuses cannot be located, pull out all the fuses and relays in the fuse box.

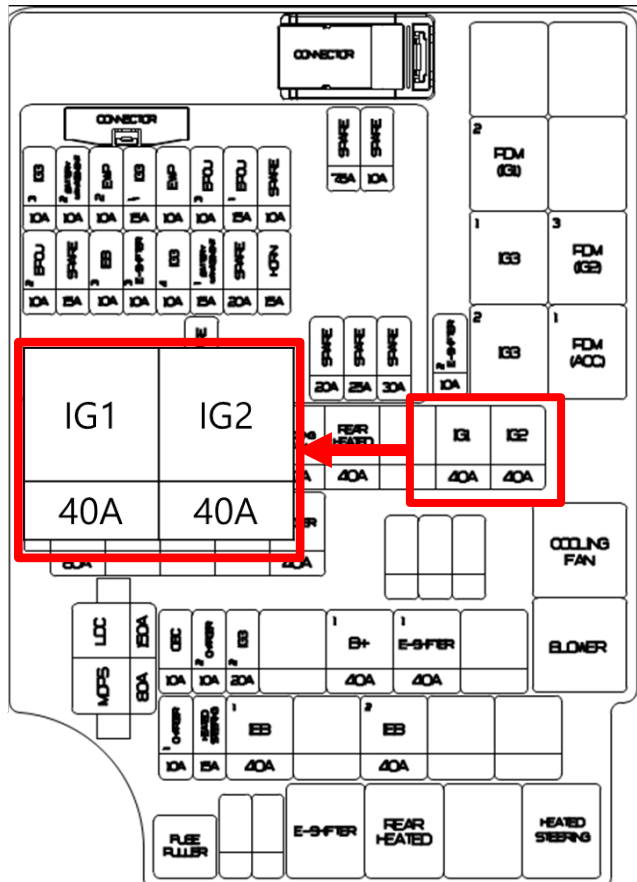

3. Disable direct hazards / safety regulations

5. Remove the safety plug and disable the high voltage battery

If previously mentioned methods of disabling the vehicle's system are unsuccessful, any emergency procedures involving the electric vehicle may cause the accidental deployment of undeployed airbags and electric shock from high-voltage components.



CAUTION Electrocutation Risk

- *Before engaging in any emergency response procedures, ensure the vehicle is disabled and wait 5 minutes to allow the capacitor in the high voltage system to discharge to avoid electrocution.*
- *Exposed cables or wires may be visible inside or outside the vehicle. Never touch the metal chassis wires, cables, connectors, or any electric components before disabling the system, and/or shorted to the vehicle chassis.*

Failure to follow these instructions will lead to serious bodily injury or death by electrocution.

4. Access to the occupants

4.1 Extraction Operations

The KONA EV is an electric model. Because of the high voltage components contained therein, first responders should exercise extreme caution when they extract occupants in the car. Before performing any extraction operations, the first responders should "Identify, Immobilize and Disable" the vehicle as discussed in sections on emergency procedures.

4.2 Vehicle Stabilization

Use standard stabilization (lift) points, as shown to the right. Always be sure to connect to a structural member of the vehicle and avoid placing cribbing under high voltage cables, and other areas not normally considered acceptable.

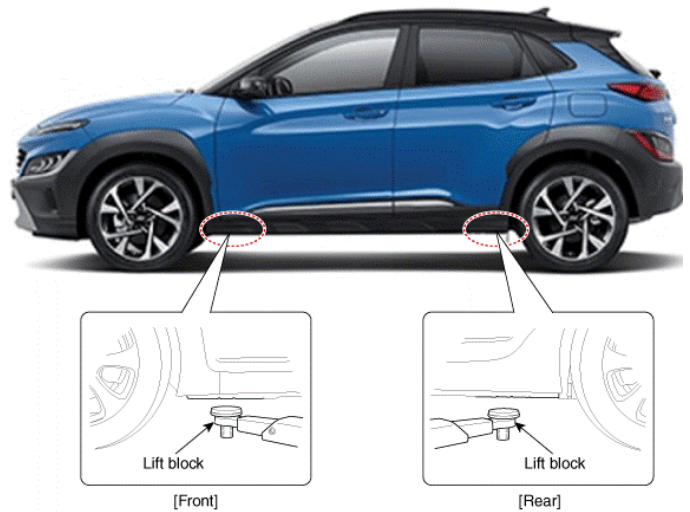

4.3 Extraction tools and procedure

When responding to an incident involving a KONA EV, we recommend that the first responders follow their organization's standard operating procedures for dealing with vehicle emergencies.

When the first responders cut the vehicle, they should always pay special attention to the airbag system, orange colored high voltage cables and other high voltage components so that the parts are not damaged and to prevent a risk of electric shock or explosion.

4. Access to the occupants

4.4 Location of ultra-high strength steel

In these images, high strength steel is used in the areas colored in blue and ultra-high strength steel is used in the red colored areas. Depending on the tools used, ultra high strength steel can be challenging or extremely difficult to cut. If necessary, use a workaround technique.

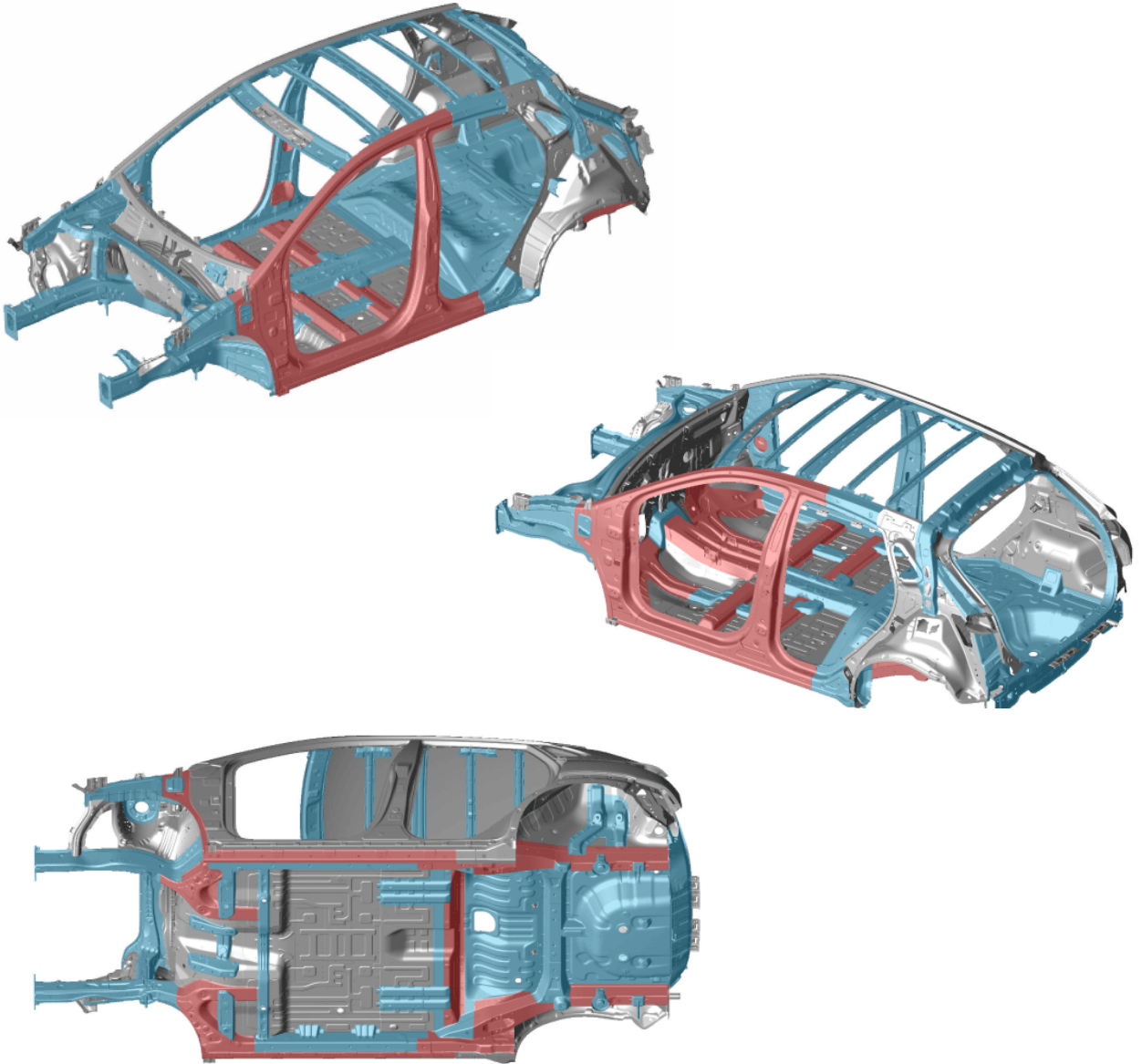









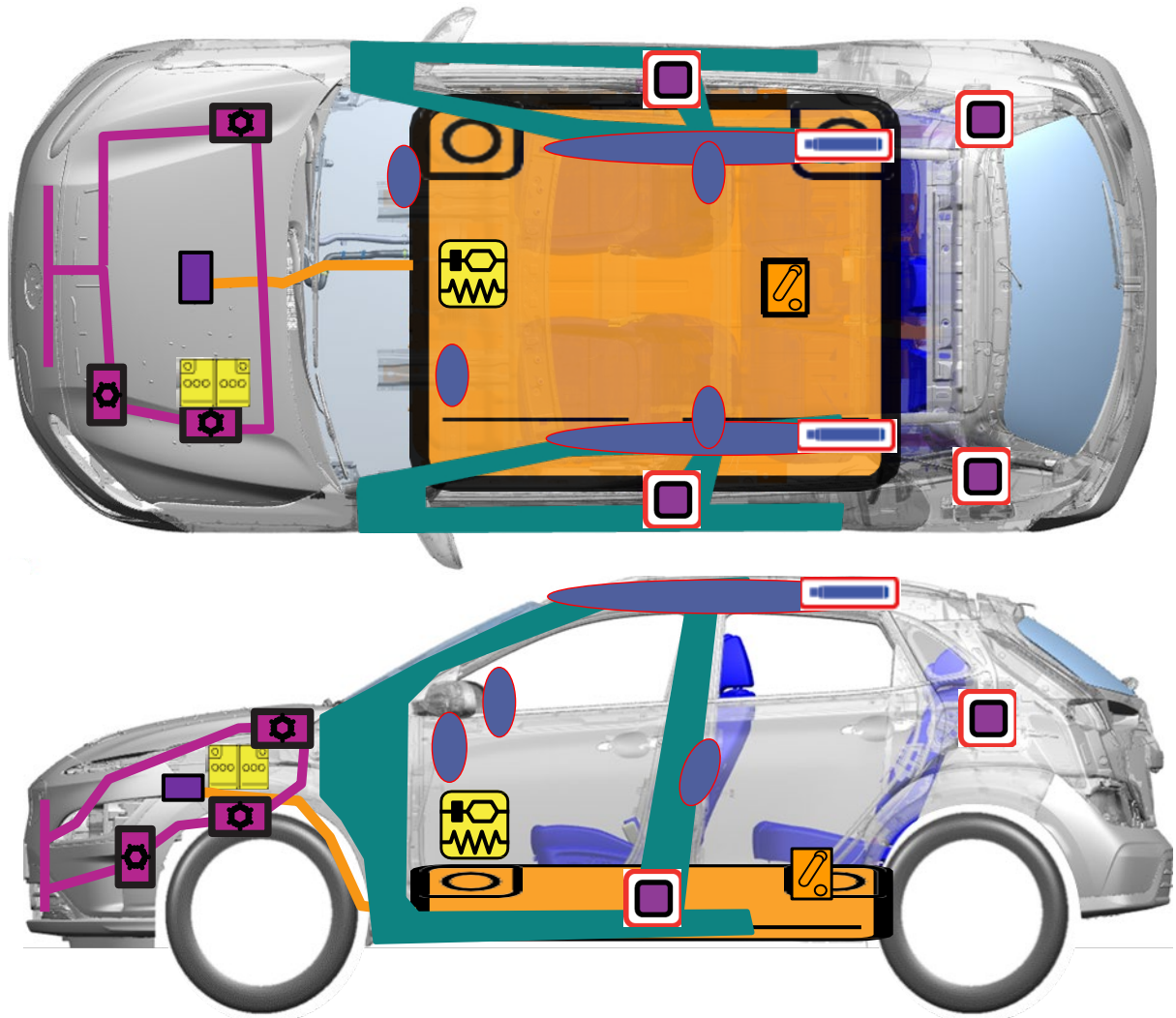



- Mild steel
- High strength steel
- Ultra-high strength steel

4. Access to the occupants

4.5 Occupants rescue guide

When dealing with an emergency situation, check the components as below.



 Supplemental Restraint System Control Module (SRSCM)	 Airbag	 Airbag Gas Inflators
 High voltage cable	 12 Volt Battery	 Air-conditioning line
 High Voltage Disconnect	 OBC (On – Board Charger)	 Ultra-High Strength Steel
 High Voltage Battery	 Air-conditioning component	 Seat belt pretensioner

5. Stored energy / liquid / gases / solids

5.1 High voltage system

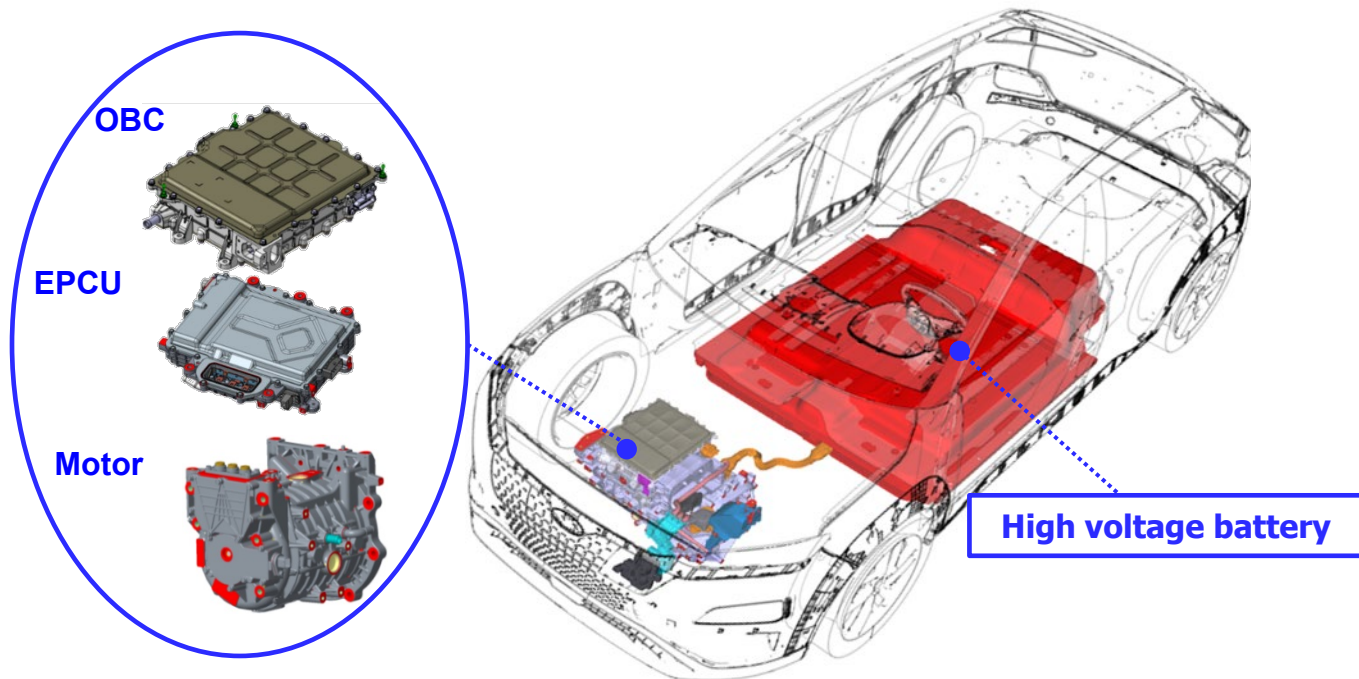

EPCU

The EPCU is the main High Voltage control unit & includes an Inverter and LDC (Low Power DC-DC Converter) in one housing. The inverter converts DC to AC to supply electricity to the motor. It also converts AC to DC to charge the high voltage battery. The LDC converts high voltage electricity to 12 voltage to charge the 12 Volt auxiliary battery.

⚠ CAUTION Capacitor in EPCU

- *There is the capacitor inside the EPCU. Wait 5+ minutes for the capacitor to discharge after removing the service plug.*

On-Board Charger (OBC)

The OBC is the High Voltage battery charging equipment that converts external AC to DC or direct DC to DC, to charge the high voltage battery.

Motor

The electric motor of the EV converts electrical energy into motive force with a Max. power of 201Hp (150kW) and Max. torque of 291lb-ft (395Nm).

5. Stored energy / liquid / gases / solids

5.1 High voltage system

High voltage battery

The High Voltage Lithium-ion polymer battery supplies and stores electric energy, to the traction motor, and is located under the KONA EV chassis.

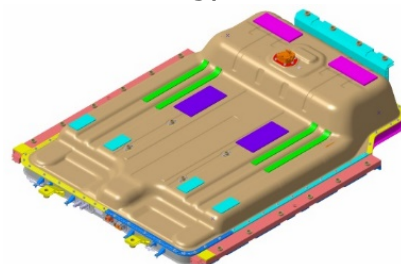

12 Volt auxiliary battery

The 12 Volt auxiliary battery is located in the left side of the electric motor room, and powers all of the vehicle's standard electronics like radio, lights, door locks, power windows, etc. Also, it powers the EPCU (Electric Power Control Unit) which controls the high voltage current to main electronic systems like the motor and high voltage junction box.

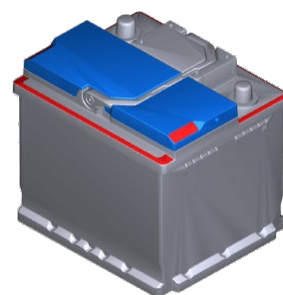

※ Specification

Motor		Type	Permanent magnet synchronous motor
		Max. Output (kW)	Extended : 150 Economical : 100
		Max Torque (Nm)	395
EPCU	Inverter	Input Voltage(V)	245 ~ 421
	LDC	Max. Output (kW)	1.8
High Voltage Battery		Type	Lithium-ion polymer
		Rated Voltage (V)	Extended : 352.8 (240~412) Economical : 324 (225~387)
		Energy (kWh)	Extended : 64 Economical : 39.2
		Quantity for Pack (Cell / Module)	Extended : 98 cells / 5 modules Economical : 90 cells / 3 modules

5. Stored energy / liquid / gases / solids

5.2 High voltage orange cabling

The High Voltage cabling is orange, per Society of Automotive Engineers (SAE) standards. Cables run under the floor of the vehicle and connect the High Voltage Battery to the EPCU, Motor, LDC, Inverter, OBC, A/C compressor and other High Voltage components located towards the front of the vehicle.

The presence of orange cables under the hood, in the under-floor battery compartment, or High Voltage cables under the car, identifies the vehicle as an electric vehicle.

CAUTION

- *Never cut or disconnect the high voltage orange cabling and connectors without first disabling the High Voltage system by removing the safety plug (refer to page 10).*
- *Exposed cables or wires may be visible inside or outside the vehicle. Never touch the metal chassis wires, cables, connectors, or any electric components before disabling the system, and; or shorted to the vehicle chassis.*

Failure to follow these instructions will lead to serious bodily injury or death by electrical shock.

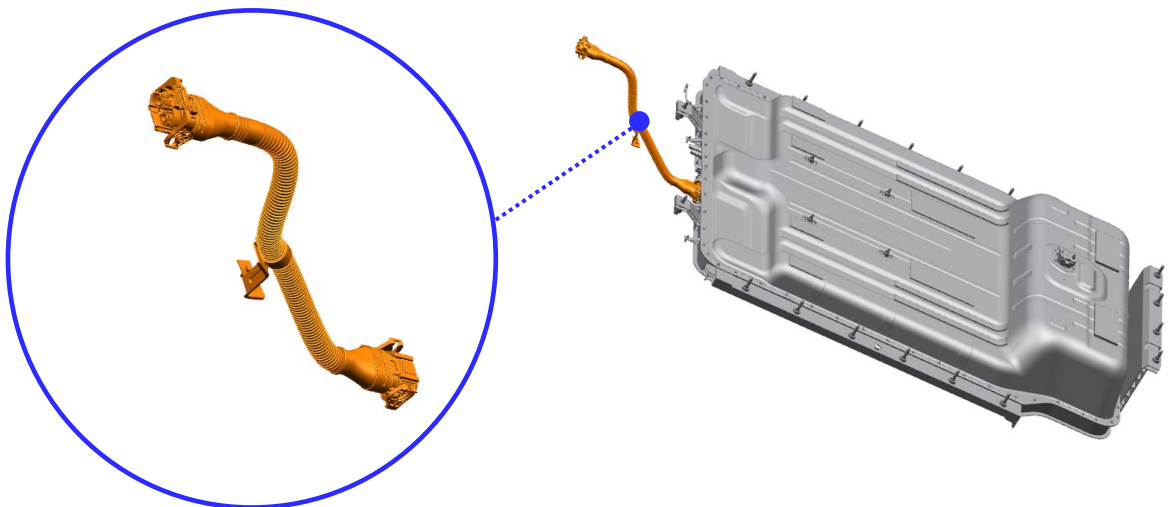

6. In case of fire

6.1 Firefighting Operations

Strict precautions must be taken while conducting firefighting operations due to following Reasons:

- Lithium-ion Polymer batteries contain gel electrolyte that can vent, ignite, and produce sparks when subjected to temperatures above 300°F.
- Vehicle may burn rapidly with a flare-burning effect.
- Even after the high-voltage battery fire appears to have been extinguished, renewed or delayed fire can occur.
 - Use a thermal imaging camera to ensure the high voltage battery is completely cooled before leaving the incident.
 - Always advise fellow emergency responders and civilians that there is a risk of the battery re-ignition.
 - In a fire, submersion or a collision that has compromised the high voltage battery, store the vehicle in an open area with no exposure within 50 feet. Alternatively, a damaged vehicle or battery pack may be stored in a barrier of earth, steel, concrete, or solid masonry.
- A burning battery could release hydrogen fluoride, carbon monoxide, and carbon dioxide gasses. Use NIOSH/MSHA approved full-face self-contained breathing apparatus (SCBA) with full protective gear. Even if the high-voltage battery pack is not directly involved in a vehicle fire, approach the vehicle very carefully.

6.2 Extinguishers

- Small fires that do not involve the high voltage battery should be extinguished using an ABC fire extinguisher. (ex. Fire caused by wiring harnesses, electrical components, etc.)
- Do not attempt to extinguish fires that involve the high voltage battery with small amounts of water as this can result in electrocution. Fires that involve the high voltage battery should be extinguished using large amounts of water (Minimum 2,650 Gallons) to cool the high voltage battery. Fire fighters should not hesitate to pour larger amounts of water on the vehicle in such scenarios. Make sure the battery is fully cooled to avoid fire re-ignition.

6. In case of fire

6.3 How to deal with the situation

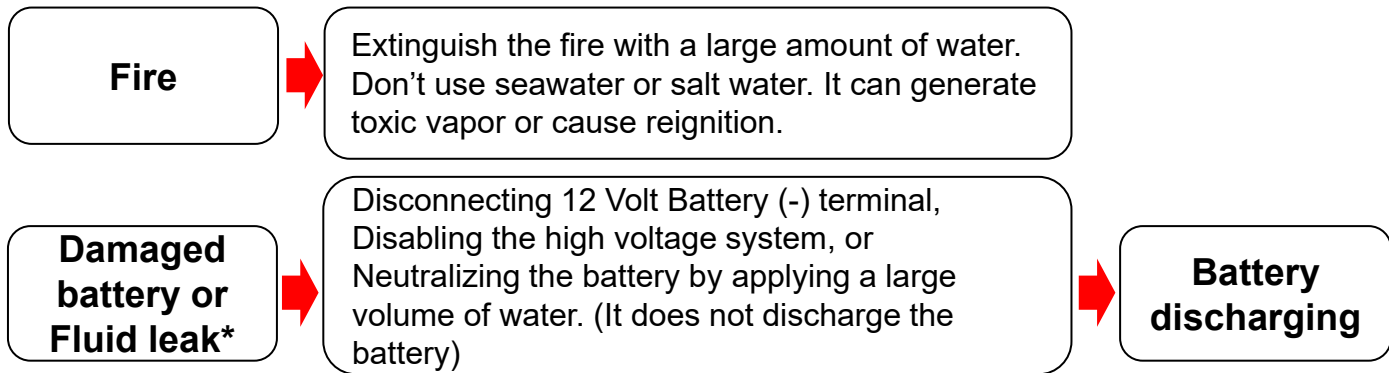

*If electrolyte solution leakage, or any damage to the High Voltage battery casing is observed

6.3.1 Vehicle fire

- You must use a large volume of water (Minimum 2,650 Gallons) to cool down the battery.
- If water is put into the high voltage battery casing, it will help cool down the battery. (But never attempt to penetrate the High Voltage battery or its casing to apply water.)



- Soaking the vehicle in a container filled with water can be an effective way to extinguish the fire.

6. In case of fire

6.3.2 High Voltage Battery Damage and Fluid Leaks

If electrolyte solution leakage, or any damage to the Lithium ion battery casing is observed, the first responders should attempt to neutralize the battery by applying a large volume of water to the battery pack while wearing appropriate Personal Protective Equipment (PPE). The neutralization process helps stabilize the thermal condition of the battery pack but does not discharge the battery.

- Do not put any smoke, spark, or flame around the vehicle.
- Do not touch or step on the spilled electrolyte solution.
- If electrolyte solution leak occurs, wear appropriate solvent resistant PPE and use soil, sand, or a dry cloth to clean up the spilled. Be sure to adequately ventilate the area.

CAUTION Electrolyte Irritation

The high voltage battery contains electrolyte solution. To avoid exposure to electrolyte solution and serious personal injury, always wear appropriate solvent resistant PPE (Personal Protective Equipment) and SCBA (Self-Contained Breathing Apparatus).

- *Electrolyte solution is an eye irritant – In the event of contact with eyes, rinse with plenty of water for 15 minutes.*
- *Electrolyte solution is a skin irritant. Therefore, in the event of contact with skin, wash off with a soap.*
- *Electrolyte liquid or fumes coming into contact with water will create vapors in the air from oxidization. These vapors may irritate skin and eyes. In the event of contact with vapors, rinse with plenty of water and consult a doctor immediately.*
- *Electrolyte fumes (when inhaled) can cause respiratory irritation and acute intoxication. Inhale fresh air and wash mouth with water. Consult a doctor immediately.*

6. In case of fire

6.4 High Voltage Battery re-ignition by stranded energy

Damaged cells in the high voltage battery can experience thermal runaway* and reignition. To prevent reignition, responding emergency personnel need to be aware of the risk of stranded energy* which remains in the damaged cells and lead to reignition.

*Thermal runaway : The originating cause of thermal runaway is generally short-circuiting inside a battery cell and a resulting increase in the cell's internal temperature. Battery produces heat with thermal runaway and it can spread from one battery cell to many cells, in a domino effect.

*Stranded energy : Energy remains inside any undamaged battery cells after the accident. That stranded energy can cause a high voltage battery to reignite multiple times after firefighters extinguish the fire.

How to prevent reignition (Mitigating stranded energy risk)

Use a thermal imaging camera to ensure the high voltage battery is completely cooled before leaving the incident.

Always advise second responders that there is a risk of the battery re-igniting.

1. 12 Volt battery (-) terminal disconnection (To depower battery management system)
2. High voltage shut off
*refer to page 7-11
3. Discharging the high voltage battery
*refer to page 24-25

7. In case of submersion

7.1 Submerged or Partially Submerged Vehicles

Some emergency responses can involve a submerged vehicle. KONA EV that is submerged does not have high-voltage components on the vehicle's body or framework. It is safe to touch the vehicle's body or framework if there is no severe damage to the vehicle, whether it is in water or on land.

In the event the vehicle is submerged or partially submerged, remove the vehicle from the water before attempting to disable the vehicle. Drain the water from the vehicle.

Use one of the methods described in page 8-12 to disable the vehicle.

Then, discharge the battery by referring to page 25-26.

CAUTION

- *If severe damage causes high voltage components to become exposed, responders should take appropriate precautions and wear appropriate insulated personal protective equipment.*
- *Do not attempt to remove a safety plug while the vehicle is in water.*

Failure to follow these instructions can lead to death or serious injury by electrocution.

8. Towing / Transportation / storage

8.1 Towing and Transportation

In the event of an accident, the high voltage system must be disabled. The safety plug must be removed from the high voltage battery according to one of the methods described in page 8-12 to disable the vehicle.

Towing the KONA EV Vehicle is not different from towing a conventional FWD vehicle.

If emergency towing is necessary, we recommend having it done by an authorized Kia dealer or a commercial tow-truck service. Proper lifting and towing procedures are necessary to prevent damage to the vehicle.

The use of wheel dollies or flatbed is recommended.

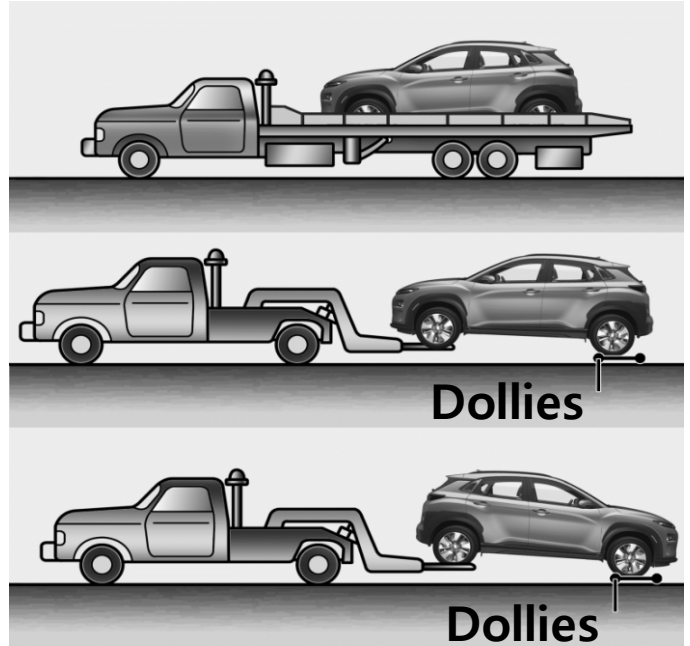

CAUTION

- *Do not tow with sling-type equipment. Use wheel lift or flatbed equipment.*
- *Never tow the vehicle with the front wheels on the ground (forward or backward), as this may cause fire or damage to the motor.*

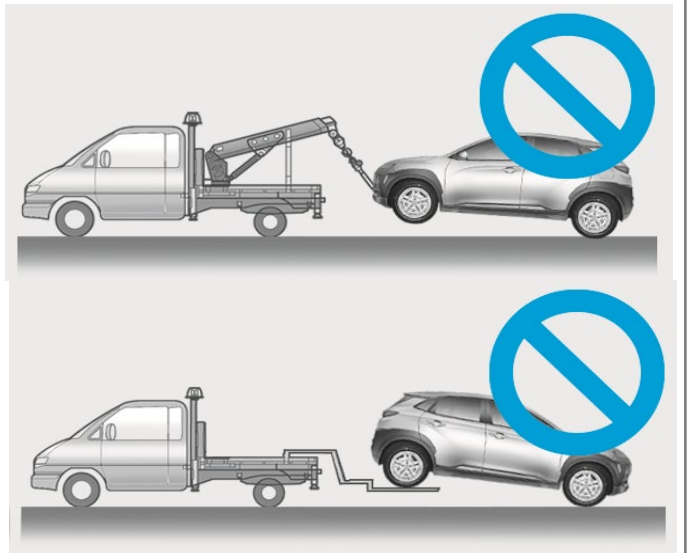

8. Towing / Transportation / storage

8.2 Storage of damaged vehicle with the damaged battery

- Drain fluids and water, then disconnect the negative (-) terminal of the 12 V battery before storing a damaged vehicle.
- In addition, remove the water inside the battery or vehicle, then remove the service plug from the high voltage battery before storing a damaged vehicle.
- Place the vehicle in an open space away from any structure, vehicle, or building.
- Then, keep on eye on the vehicle until the discharging procedures are completed.
- If the battery can be removed from the vehicle by moving the vehicle on a lift, remove and discharge the battery.
- If the battery can't be removed, set up a water pool until the entire battery is submerged. (See below)

Water pool condition : tap water or pond water that does not contain salt

- Maintain this water level for at least 90 hours.
- Put salt into the water pool to make 3.5% salt water.
- Wait for additional 48 hours in salt water.
- Then, drain the water by using BMU cover (A) and dry it.

CAUTION

- DO NOT USE SALT WATER FOR THE FIRST STEP.
- A large volume of flammable gas can be generated in salt water due to electrolysis.
- After submerging the vehicle in pure water for at least 90hours, put salt in the water pool.

Battery discharging



BMU service cover (A)

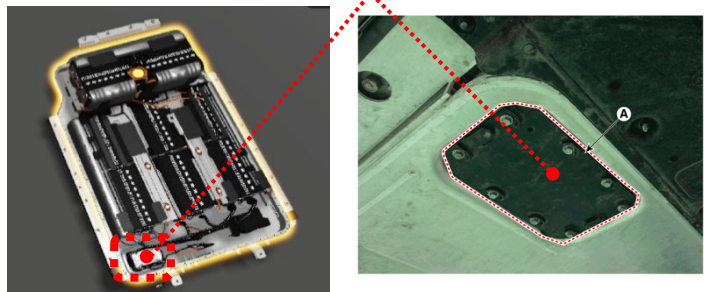

8. Towing / Transportation / storage

8.3 Battery Storage

- To store the damaged battery safely, the battery must be discharged.
- If the battery can be removed from the vehicle, discharge the battery to prevent re-ignition.

CAUTION

- *Extinguish all smoke, spark, flame around the vehicle.*
- *Electrolyte solution is an eye and skin irritant, so exercise caution.*
- *Do not touch or step on the spilled electrolyte.*
- *If electrolyte leak occurs, wear appropriate solvent resistant PPE and use soil, sand, or a dry cloth to clean up the spilled electrolyte. Be sure to adequately ventilate the area.*

- Prepare water that does not contain salt such as tap or pond water.
- Leave the battery in water for at least 90 hours.
- Then put salt into the water pool to make 3.5% salt water.
- Wait for additional 48 hours in salt water.
- Then take out the battery from the water pool and drain and dry it.

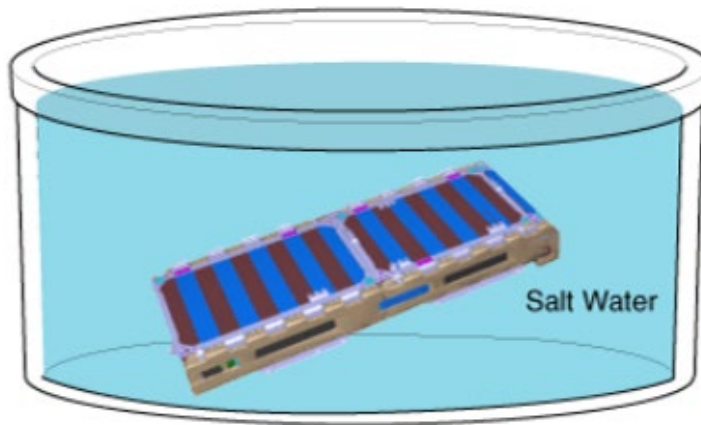

9. Important additional information

9.1 Emergency Starting

Jump Starting

Do not attempt to jump start the high voltage battery, as it cannot be jump started. In case of full discharge of the high voltage battery, the vehicle must be towed as mentioned on the previous page.

If the 12 Volt auxiliary battery is discharged, connect a starting device to the jump terminal in the motor room as you would any 12 Volt battery (see image). Refer to the “Emergency Starting” section of the Owner’s Manual for additional information. Connect jumper cables in the order shown in the image and disconnect in reverse order.

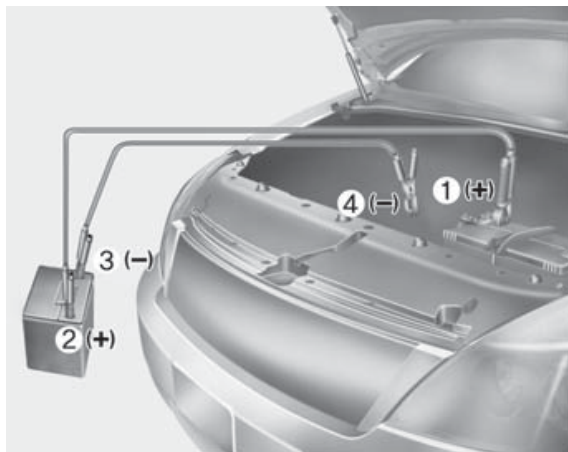

CAUTION

Do not attempt to jump start the KONA EV high voltage battery.

Failure to follow these instructions will lead to serious bodily injury or death by electrical shock.

Jump Starting Procedure

1. Make sure the booster battery is 12-Volt and that its negative terminal is grounded.
2. If the booster battery is in another vehicle, do not allow the vehicles to come in contact.
3. Turn off all unnecessary electrical loads.
4. Connect the jumper cables in the exact sequence shown in the illustration.

First connect one end of a jumper cable to the positive terminal of the discharged battery (1), then connect the other end to the positive terminal on the booster battery (2).

Proceed to connect one end of the other jumper cable to the negative terminal of the booster battery (3), then the other end to a solid, stationary, metallic point away from the fuse box (4).

9. Important additional information

9.2 Airbag system (SRS: Supplemental Restraint System)

Airbag

Six airbags are installed in the KONA EV, located in the areas shown in the image below. Before performing any emergency procedure, make sure the vehicle ignition switch is turned off and disconnect the negative connector from the 12 Volt auxiliary battery (located in the left side motor compartment) to prevent accidental deployment of the airbags.

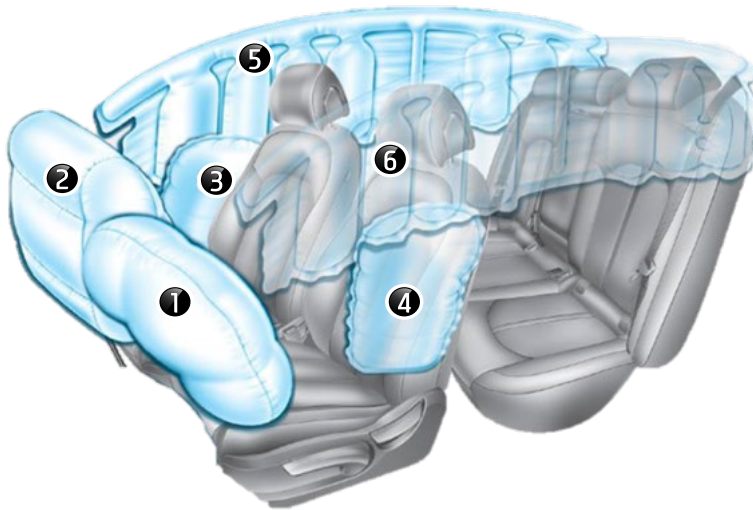

- (1) Driver front airbag
- (2) Passenger front airbag
- (3) Passenger Side airbag
- (4) Driver Side airbag
- (5) Passenger Curtain airbag
- (6) Driver Curtain airbag

NOTE: Actual air bags and seats in the vehicle may differ from the illustration.

Seat Belt Pretensioner

In the KONA EV, the driver's and front passenger's seat belts are equipped with pretensioners. When the seat belt pretensioners are activated in a collision, a loud noise may be heard and fine dust, which may appear to be smoke, may be visible in the passenger compartment. These are normal operating conditions and are not hazardous. The seat belt pretensioner assembly mechanisms may become hot during activation and may need several minutes to cool down after they have been activated.

9. Important additional information

Airbag system components

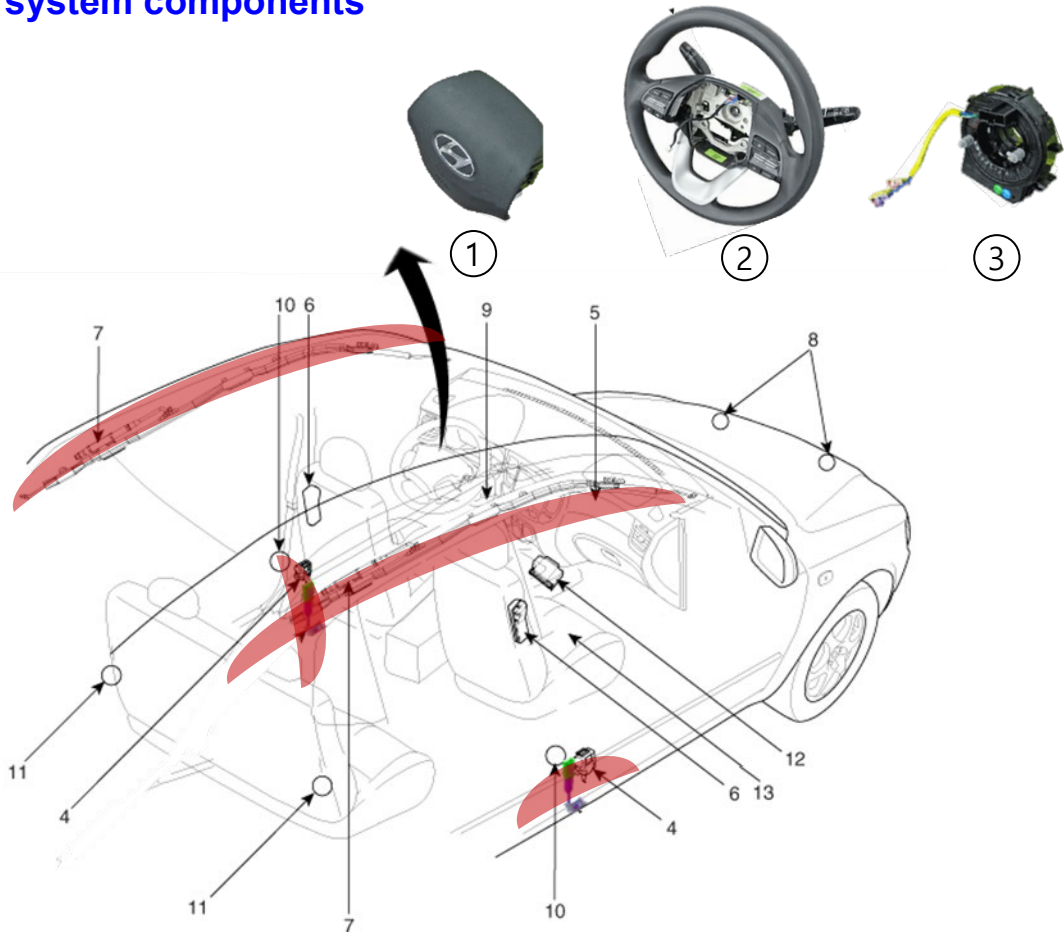

1. Driver Airbag (DAB)
2. Steering Wheel
3. Clock Spring
4. Seat Belt Pretensioner (BPT)
5. Passenger Airbag (PAB)
6. Side Airbag (SAB)
7. Curtain Airbag (CAB)
8. Front Impact Sensor (FIS)
9. Knee Airbag (KAB)
10. Pressure Side Impact Sensor (PSIS)
11. Rear Side Impact Sensor (RSIS)
12. Supplemental Restraint System Control Module (SRSCM)
14. Occupant Classification System (OCS)

9. Important additional information

Seat belt System

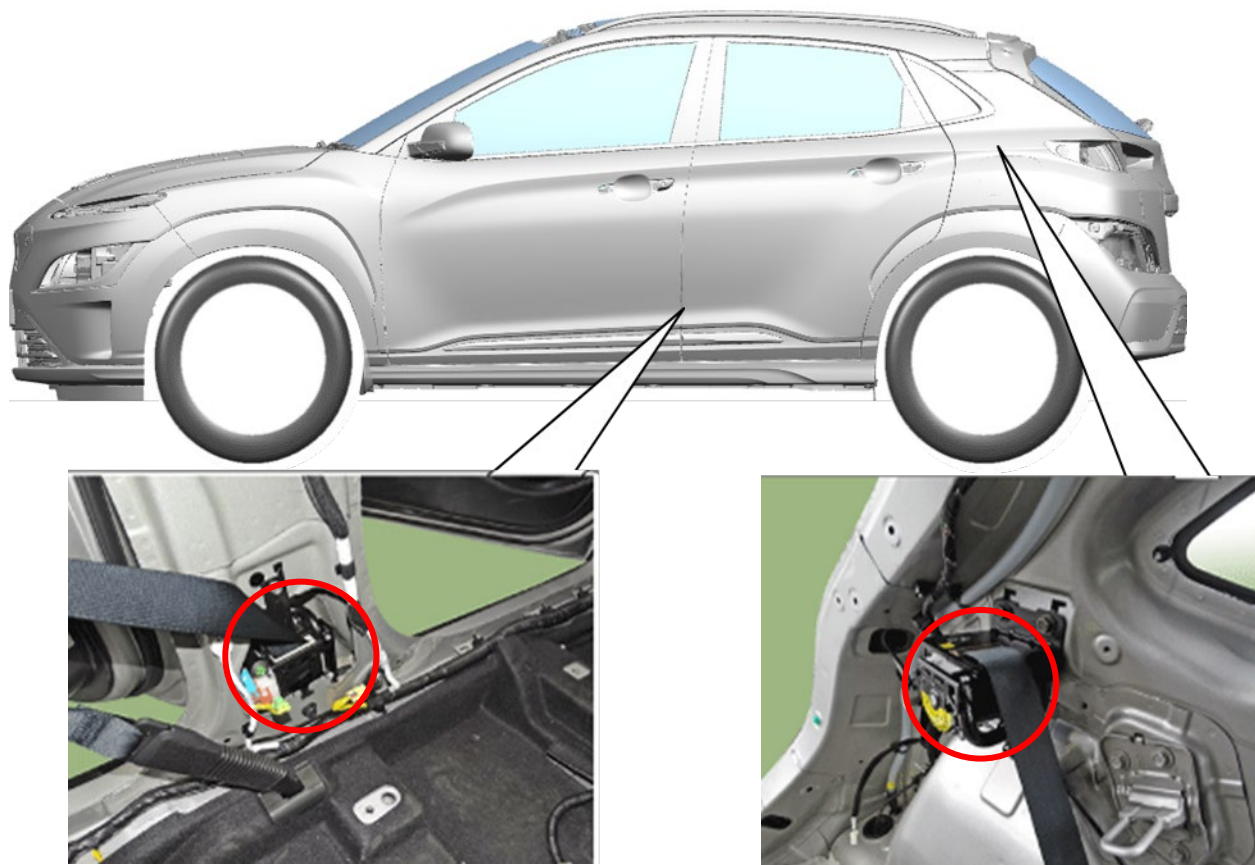

⚠ CAUTION Undeployed Airbags

To avoid injuries caused by accidental deployment of undeployed airbags

- *Do not cut the red colored part shown in the image above.*
- *Make sure the vehicle ignition switch is turned off, disconnect the negative cable from the 12 Volt auxiliary battery (located in the left side of motor room) and wait 3 minutes or longer to allow the system to deactivate.*

Failure to follow any of these instructions may result in serious injury or death from accidental deployment of the airbag system.

